



KEY FEATURES

- Available with 30° (Narrow) or 100° (wide) symmetric optics
- Designed for Hazardous locations
- Thermally managed for maximum longevity
- Adjustable mounting bracket
- Lifespan up to 100 000 hours
- Available in multiple lengths and with Colored LEDs



MODEL NUMBER SELECTOR Example: GSLEDIP36-CW-N-BLK-C1D2-12VDC

MODEL	COLOR	OPTIC	FINISH	LOCATION	POWER
GSLEDIP36				C1D2	
	CW - Cool White NW - Neutral White WW - Warm White CUS - Custom <i>Contact for custom color</i>	N -Narrow W -Wide NF -Narrow Frosted WF -Wide Frosted	BLK - Black WHT - White CUS -Custom <i>Contact for custom finish</i>	C1D2 - Class 1, Div 2 <i>GEN Available for General Locations See GSLEDIP12-GEN</i>	12VDC -12 Volts DC 24VDC -24 Volts DC

TECHNICAL SPECIFICATIONS / MAXIMUM RATINGS

HOUSING	Powder Coated Extruded Aluminum
MOUNTING	Mounting Brackets (Other Options Available See Pg2)
VOLTAGE MAXIMUM	28 VDC
TYPICAL INPUT VOLTAGE	12VDC: 11-16 VDC 24VDC: 22-28 VDC
POWER	25.2 W
CURRENT	1.3 A @12 VDC 0.66 A @ 24 VDC
CONNECTIONS	6Ft Flying Lead (Custom Lengths Available)
TEMPERATURE RANGE	-40°C – +85°C
TYPICAL CASE TEMPERATURE	~15°C Above Ambient Temperature
CERTIFICATIONS	Certified To CSA 22.2 No. 250.0 , Conforms To UL 1598 Standard, Class 1 Division 2 Groups ABCD , T3
INGRESS PROTECTION	IP54
COLOR TEMP RANGE	CW: 6500K NW: 4300K WW: 3500K
CRI VALUE	CW: 75 NW: 75 WW: 80
TOTAL LUMENS	1812
TOTAL SCOTOPIC LUMEN	3804
WEIGHT	2.1lb 0.9 kg

DIMENSIONS

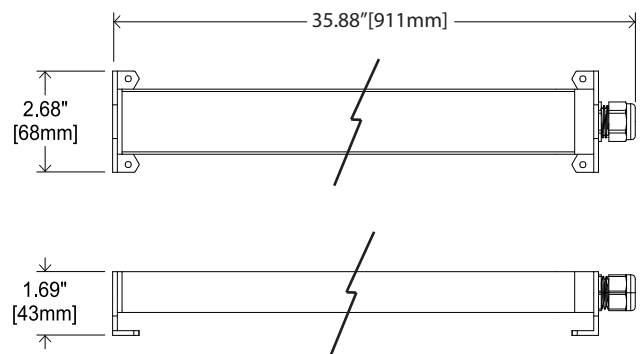

Alternate Lengths: (See respective Model Specification Sheets for details)

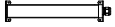
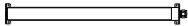
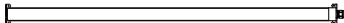
- GSLEDIP12 13.4" [340mm] 
- GSLEDIP24 24.9" [632mm] 
- GSLEDIP48 46.9" [1191mm] 

PHOTOMETRICS

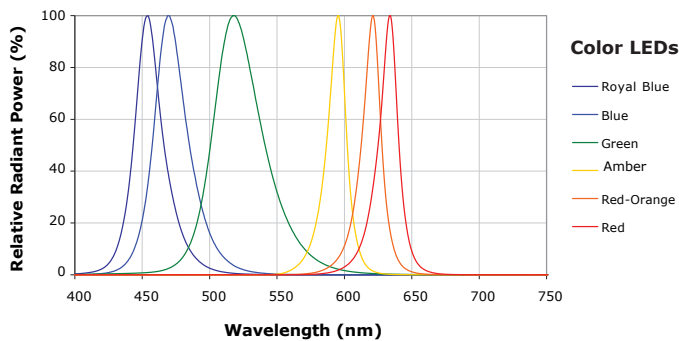
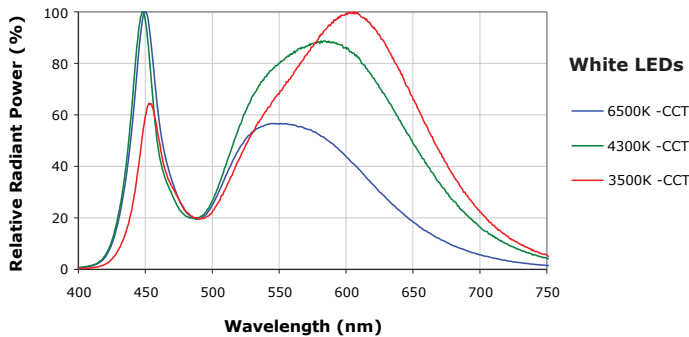

NARROW BEAM



FROSTED LENS



(Shown in White Option)

WIDE BEAM



MOUNTING OPTIONS

MOUNTING BRACKET

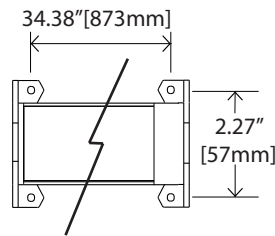

CLIP MOUNT

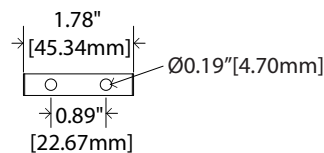

SURFACE MOUNT

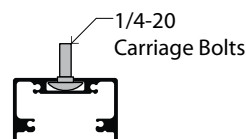
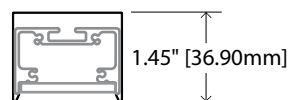

CUSTOM OPTIONS

WIRING

Other wire lengths available in 1 foot increments.

CUSTOM FINISHES

Anodized Aluminum

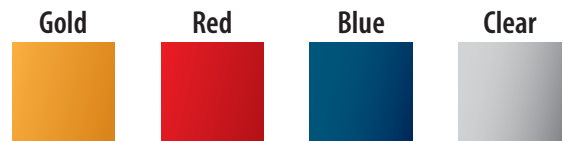

Please contact for further options

Powder Coated Aluminum



Please contact for further options